

Hydraulic Cylinder Series SC

Tailor Made Design

To Perfectly Fitted with Your Machine
and Your Specific Application



*High Quality Cylinders
for Heavy Duty Application*

CONTENTS

Technical Data & Ordering Code.....	Page 1
Series SC Data.....	Page 2
Tailor Made Cylinder Overview.....	Page 3 - 5



*High Quality Cylinders
for Heavy Duty Application*

Siamhyd Cylinder Series SC (Tailor Made)

Technical data

Series SC Cylinder: Are designed for Heavy Duty Application to meet your needs of unmatched reliability, performance and innovative designed features to help increase productivity and reduce your operating costs.

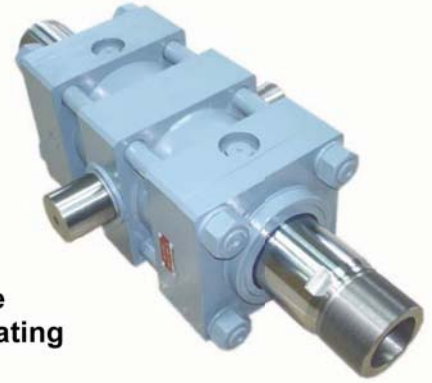

Siamhyd engineers have developed a new concept in tailor made cylinder Series SC which every cylinder needs to make simulation check before production to certify that all Series SC can be perfectly fitted with your machine and your specific application.

Additional advantage of Siamhyd Cylinder Series SC is to Up-grade and modernize of old cylinder to improve quality and specification for example, higher temperature, higher pressure, higher speed with soft stopping, longer maintenance period. All available without changing installation dimension of old cylinder.

Technical Characteristics

Working Pressure PS: Up to 700 bar

Test Pressure PT: 1.43 x PS

Bore Size: 40 – 600 mm.

Minimum Working Temperature: -200 °C

Maximum Working Temperature: +260 °C

Piston Velocity: Up to 5 M/sec



Ordering Code:

SC 125 / 050 — 200 — 6036

1 2 3 4 5

1 Hydraulic Cylinder SC series

2 Piston Ø (in mm.)

3 Piston rod Ø (in mm.)

4 Stroke length (in mm.)

5 Drawing No.



Siamhyd Cylinder Series SC (Tailor Made)

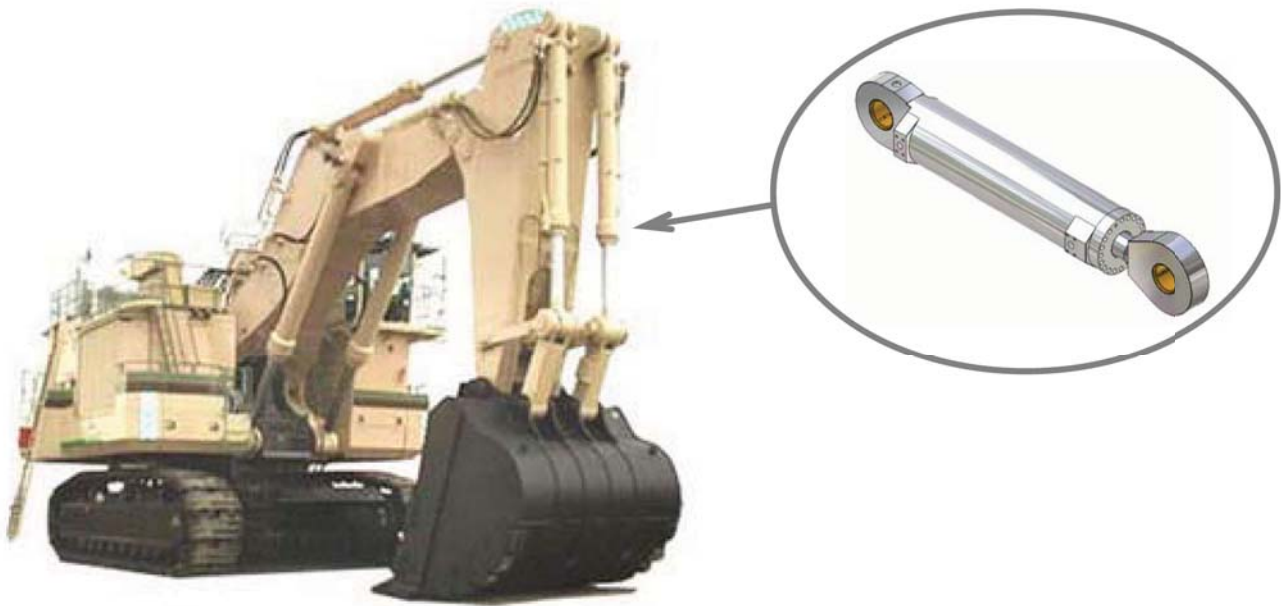

Tailor Made Cylinder Overview

SC-080/050-150-5001



SC-80/050-295-6043

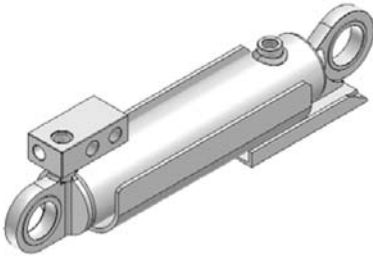

SC-150/090-100-6035

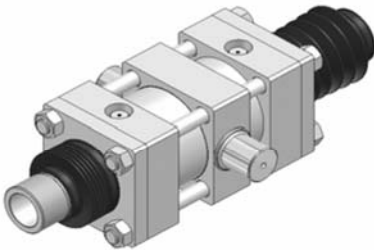

SC-040/020-100-5066

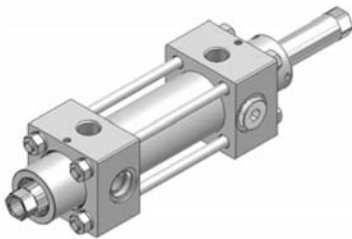

SC-80/050-275-6111

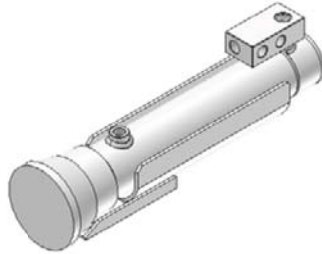

SC-160/110-270-6009

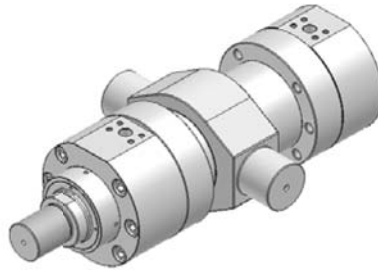

SC-125/070-125-6050

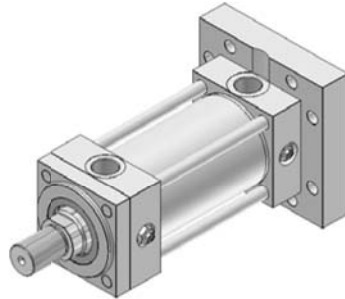

SC-125/050-200-6036

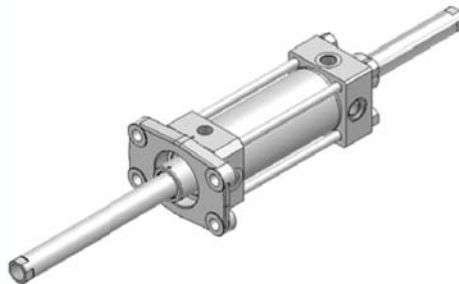

SC-100/050-513-6018

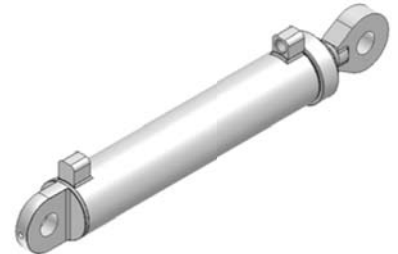

SC-100/071-240-6017

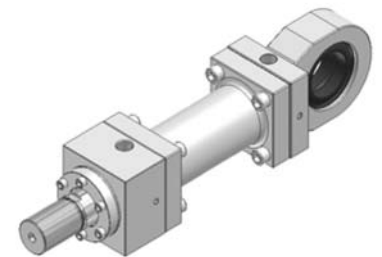

SC-180/050-134-5028

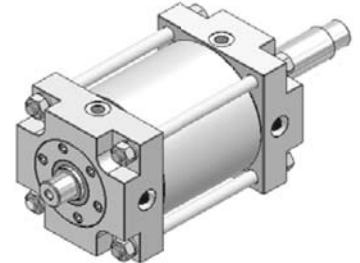

SC-125/070-250-6046

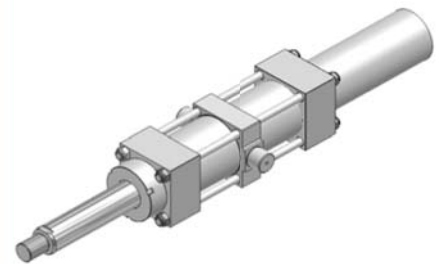

Tailor Made Cylinder Overview

SC-R90-98.5-6027



SC-245/150-260-5057



SC-300/150-284-6101

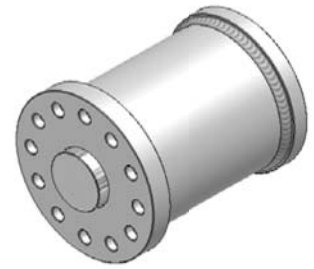

SC-304.1/331.8-670-6112

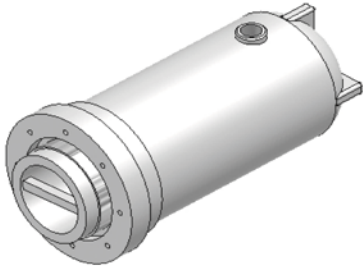

SC-508/355.6-152.4-6124

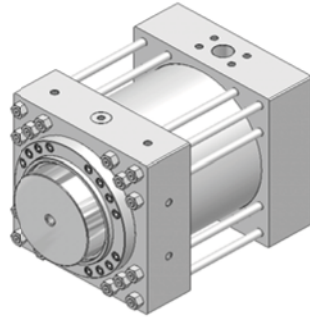

SC-160/120-50-5047

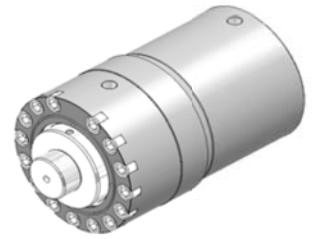

SC-040/025-325-5018

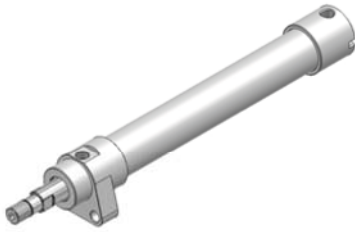

SC-040/025-336.5-6030

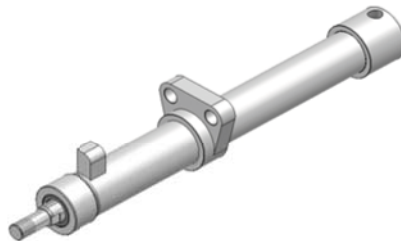

SC-063/032-315-5036

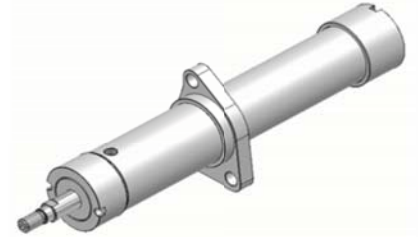

SC-080/032-580-5036

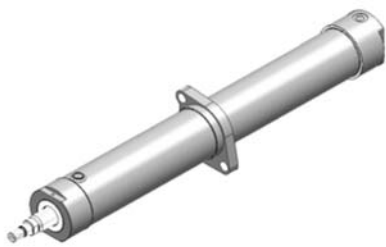

SC-040/020-451-5031

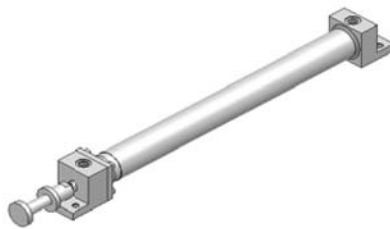

SC-100/032-1041-5037

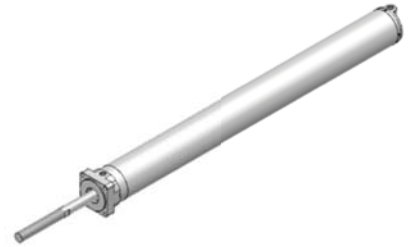

Tailor Made Cylinder Overview

SC-100/070-100-5069



SC-125/070-350-6032

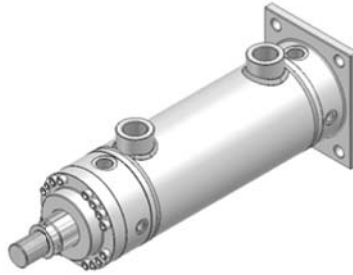

SC-050/030-050-6038

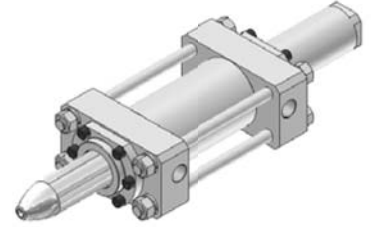

SC-280/200-50-6054

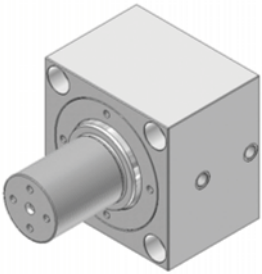

SC-180/050-134-6121

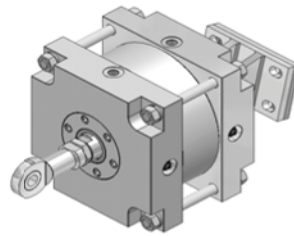

SC-RJ120-5064

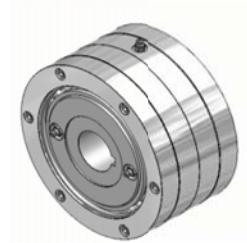

SC-080/045-300-5029

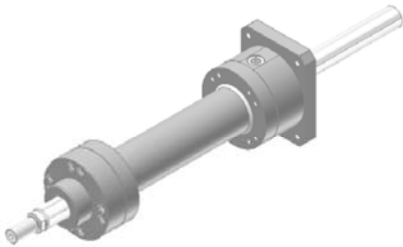

SC-160/040-019-6001

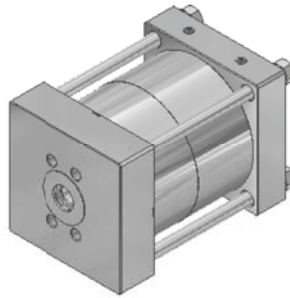

SC-070/040-195-6024

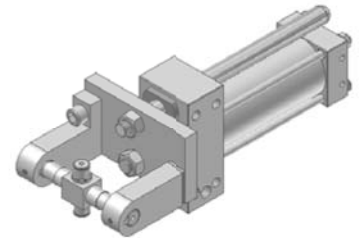

SC-080/050-297-6025

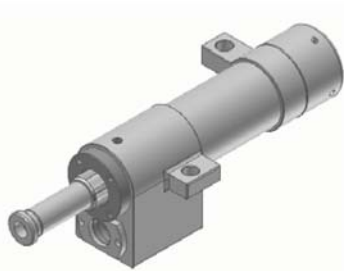

SC-150/070-35.4-5068



SC-050/020-305-5058





*High Quality Cylinders
for Heavy Duty Application*

SIAM HYDRAULIC CO., LTD.

888 Lasalle Road, Bangna, Bangkok 10260

Tel. : (66) 2748-6775 Fax. : (66) 2748-6775 Ext. 61,65

Email. : sales@siamhyd.com, Web. : www.siamhyd.com